

A Section A - A
1:25

7 T4b F01

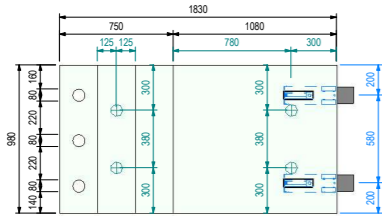

1 T4b F01
1:25

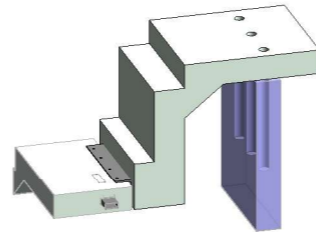
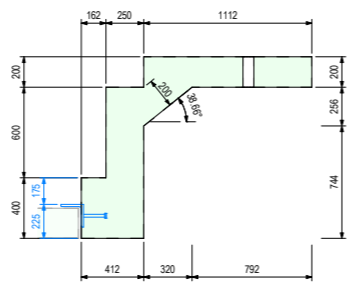

B Section B-B
1:25

8 T4b F02

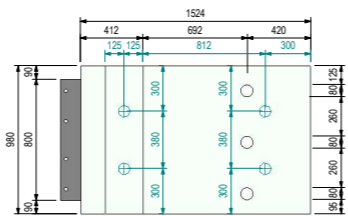

2 T4b F02
1:25

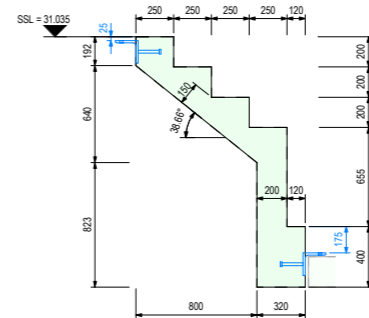

C Section C-C
1:25

3 T4b F03

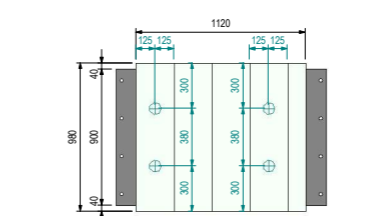

3 T4b F03
1:25

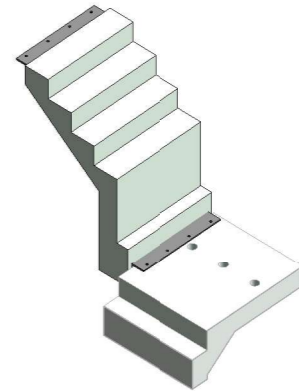

9 T4b F03

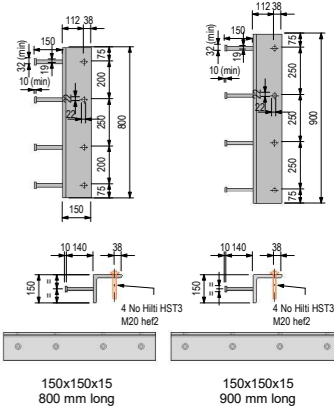

Steel Angle Detail

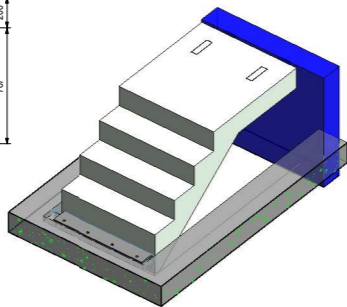
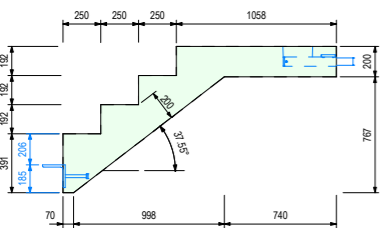

D Section D-D
1:25

10 T4b F04

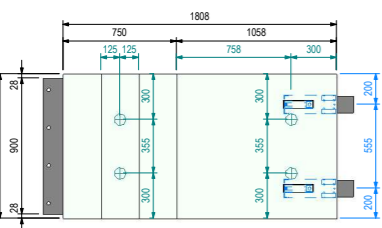

4 T4b F04
1:25

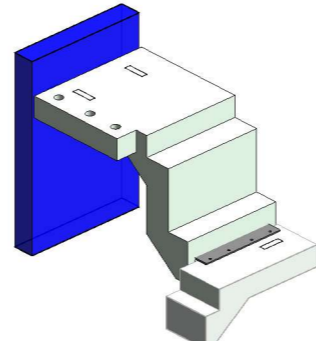
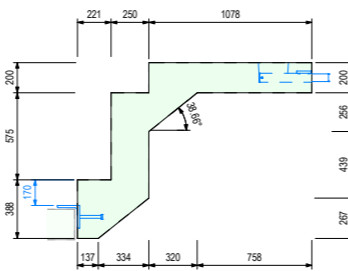

E Section E-E
1:25

11 T4b F05

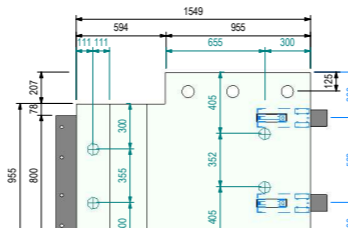

5 T4b F05
1:25

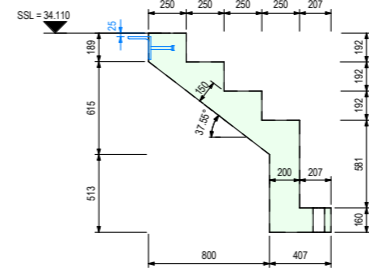

F Section F-F
1:25

6 T4b F06

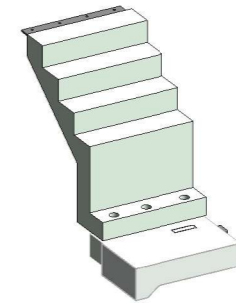
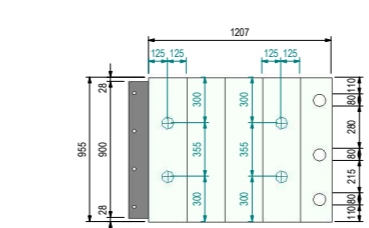

12 T4b F06

- Notes:
1. Do not scale from this drawing. Use figure dimensions only.
 2. This drawing is to be read in conjunction with all related Architects, Consultants & Sub-Contractors drawings and specifications.
 3. The contractor is advised that all design drawings and information are to be read concurrently and any discrepancies or omissions reported directly to Simtrical Structural Department.
 4. The contents of this drawing may not be reproduced in whole or in part without the prior written permission of Simtrical Ltd.

Rev	Description	By	Date	Chk'd
CO3	IC setting out 200mm from slab edge.	SP	29.03.19	SC
CO2	IC type revised.	SP	29.03.19	SC
CO1	Lifting anchors setting out added. Issued for construction.	SP	22.03.19	SC
PO2	Steel Angle Details added	SP	19.03.19	SC

3 Horizon Place, Studio Way
Breamwood
Hertfordshire, WD6 5FP

T: +44 (0) 1404 134 433
W: www.simtrical.co.uk
E: office@simtrical.co.uk

Client Details: Berkeley Homes Ltd.				
Project Details: Kidbrooke Village - Phase 3 Block D				
Drawing Title: Private Stairs Element - Level 01 Lower (Sheet 2)				
Scale: As indicated	Date: Mar 19	Drawn By: SP	Checked By: SP	Approved By: SP
Construction				
Drawing Number: P16141L-GCL-DZ-01-DR-S-GAP-20024				Revision: C03